

9 BY 9 BUILD BRIDGES (NO. 35 AND 36)

CONNECT ALL ISLANDS INTO A SINGLE GROUP BY DRAWING HORIZONTAL OR VERTICAL LINES (BRIDGES). YOU CAN DRAW A SINGLE OR DOUBLE LINE BETWEEN EACH ISLAND (NOT MORE). THE TOTAL NUMBER OF BRIDGES THAT CONNECT AN ISLAND MATCHES THE NUMBER ON IT. THE BRIDGES MAY NOT CROSS EACH OTHER.

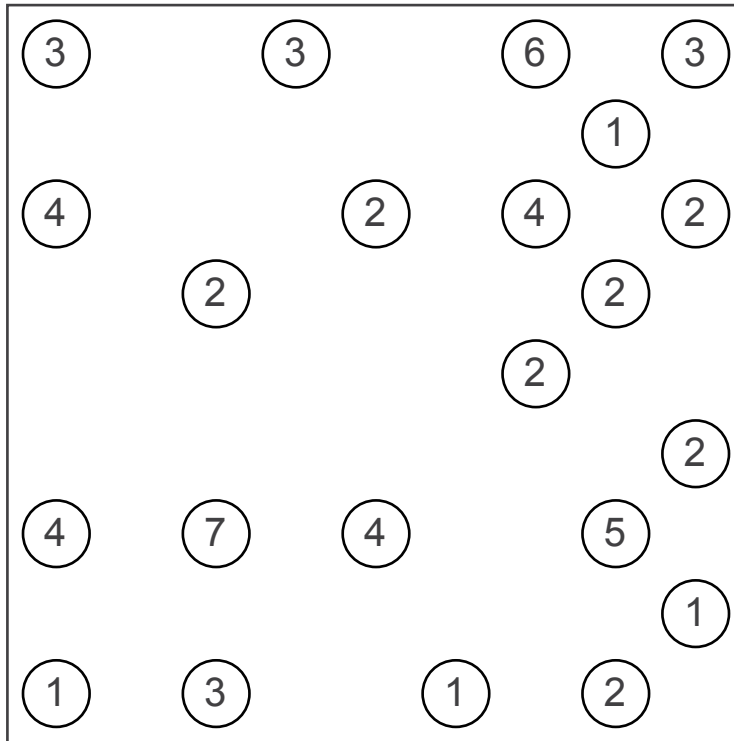

0909 BUILD BRIDGES 35

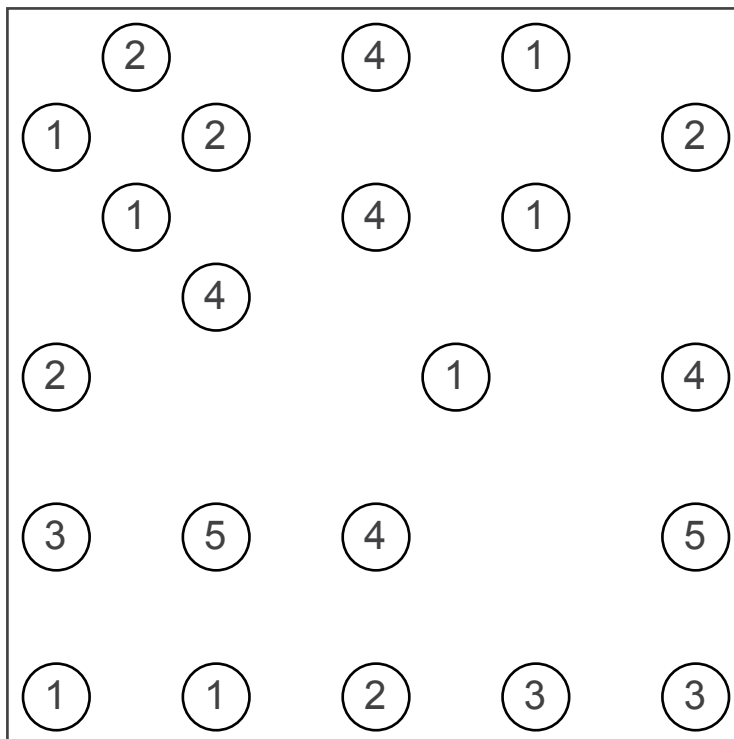

0909 BUILD BRIDGES 36

ANSWERS

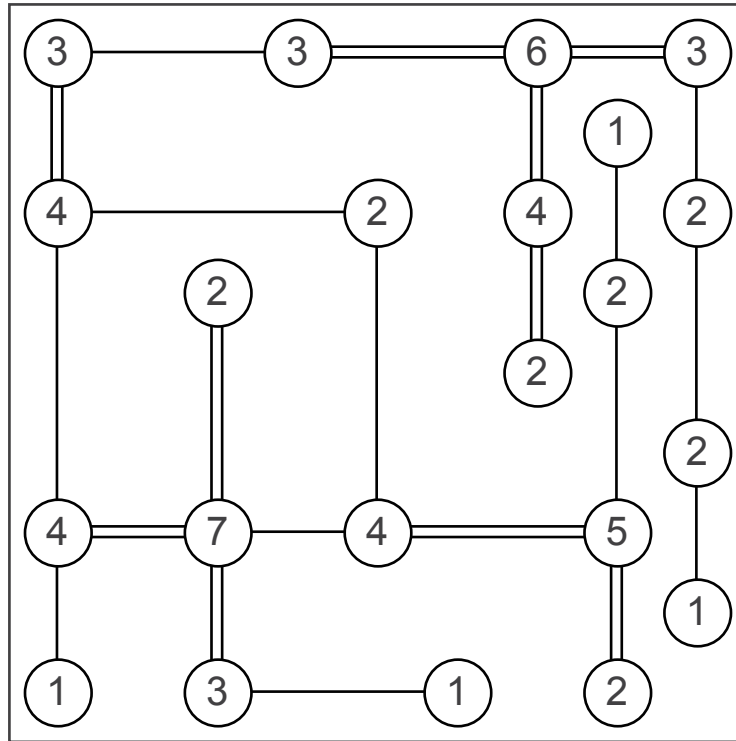

0909 BUILD BRIDGES 35

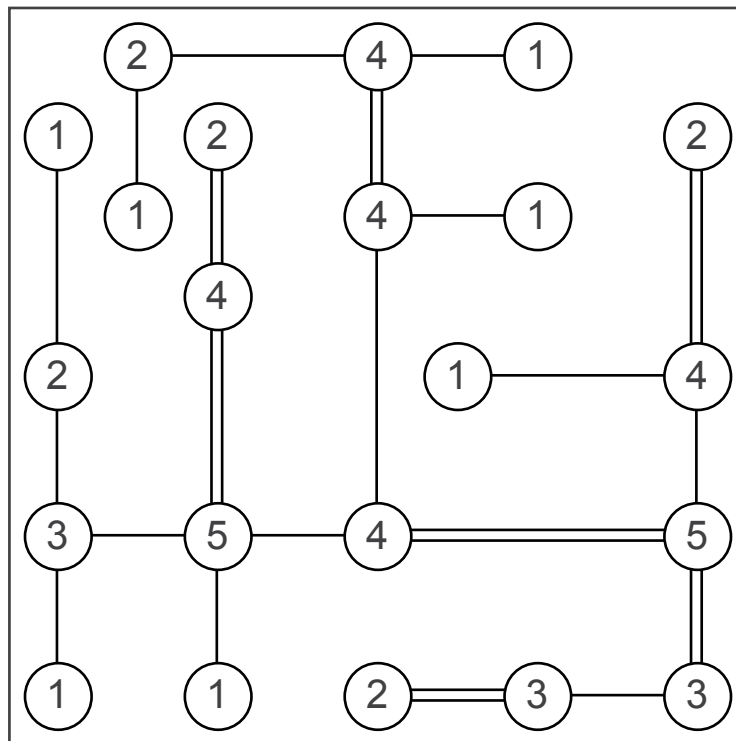

0909 BUILD BRIDGES 36