

9 BY 9 SLITHERLINK (EASY NO. 3 AND 4)

THE OBJECTIVE IS TO CONNECT DOTS IN THE GRID HORIZONTALLY OR VERTICALLY SO THAT THE LINES FORM A CONTINUOUS PATH (SLITHERLINK) WITH NO LOOSE ENDS OR BRANCHES. THE NUMBER INSIDE A DOTTED SQUARE INDICATE HOW MANY OF ITS 4 SIDES ARE PART OF THE PATH.

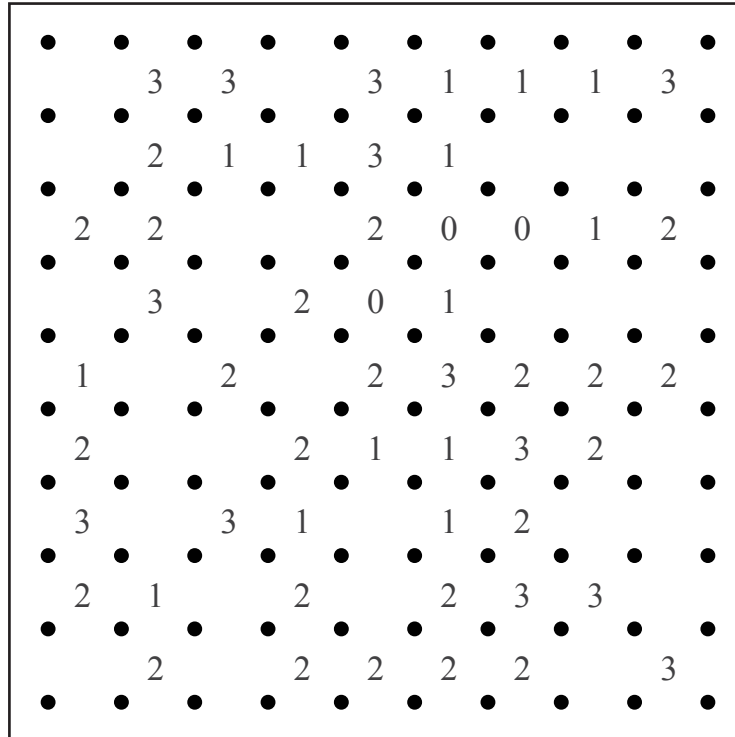

0909 SLITHERLINK EASY 3

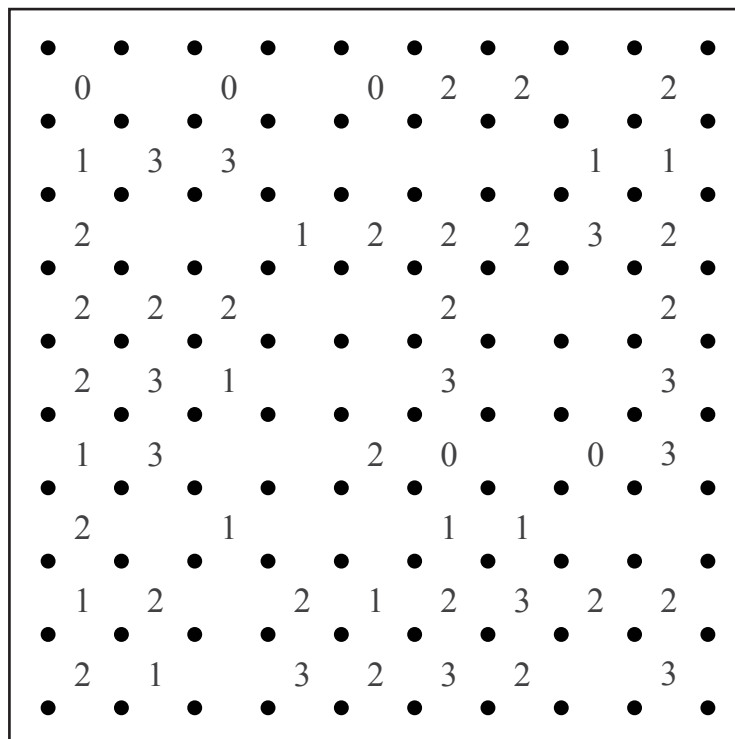

0909 SLITHERLINK EASY 4

ANSWERS

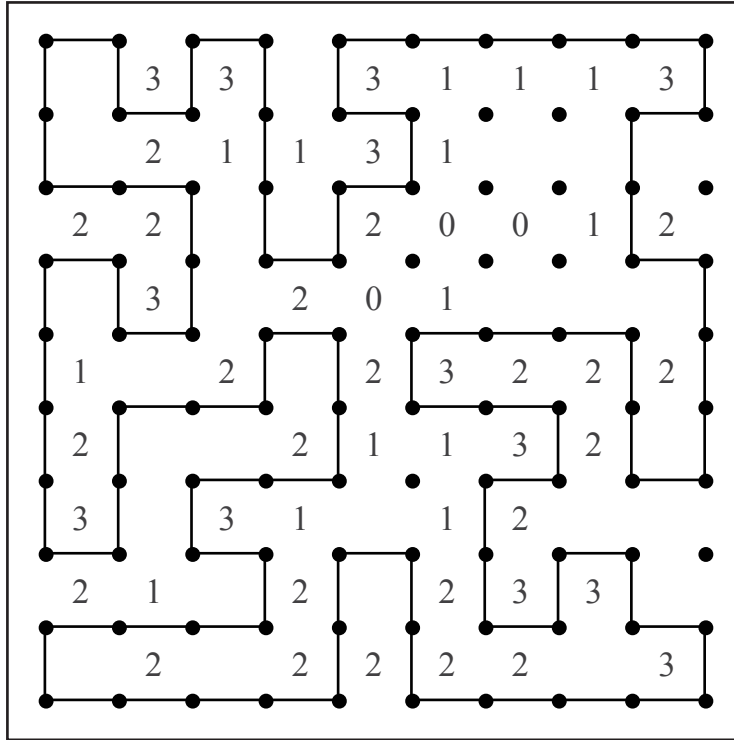

0909 SLITHERLINK EASY 3

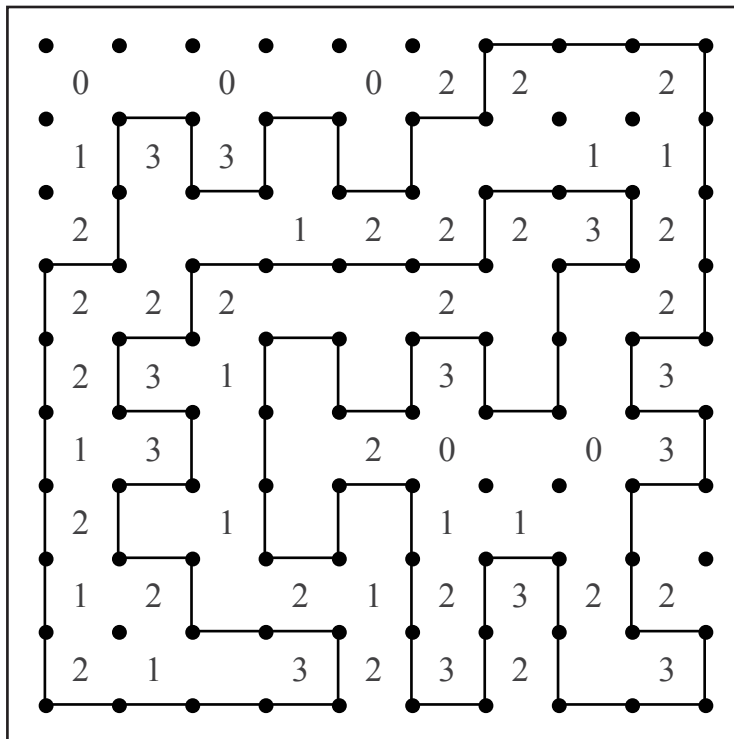

0909 SLITHERLINK EASY 4