

6 BY 6 BUILD BRIDGES (NO. 77 TO 80)

CONNECT ALL ISLANDS INTO A SINGLE GROUP BY DRAWING HORIZONTAL OR VERTICAL LINES (BRIDGES). YOU CAN DRAW A SINGLE OR DOUBLE LINE BETWEEN EACH ISLAND (NOT MORE). THE TOTAL NUMBER OF BRIDGES THAT CONNECT AN ISLAND MATCHES THE NUMBER ON IT. THE BRIDGES MAY NOT CROSS EACH OTHER.

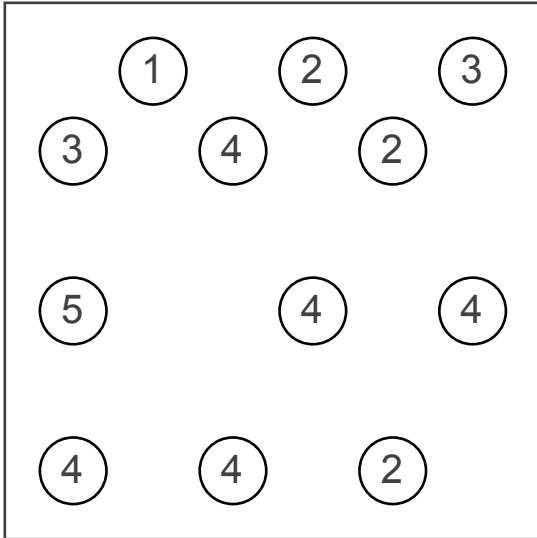

0606 BUILD BRIDGES 77

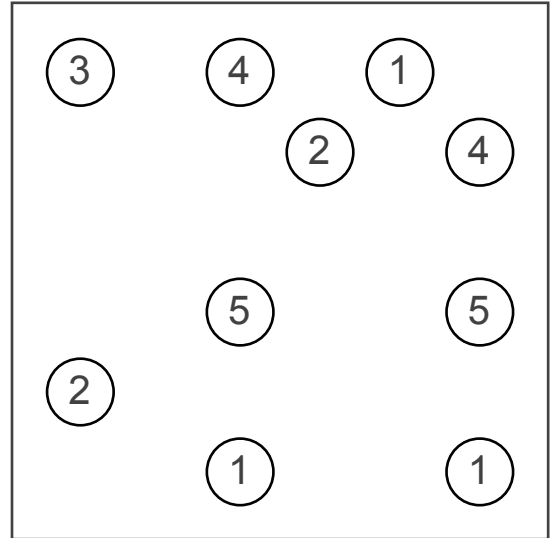

0606 BUILD BRIDGES 78

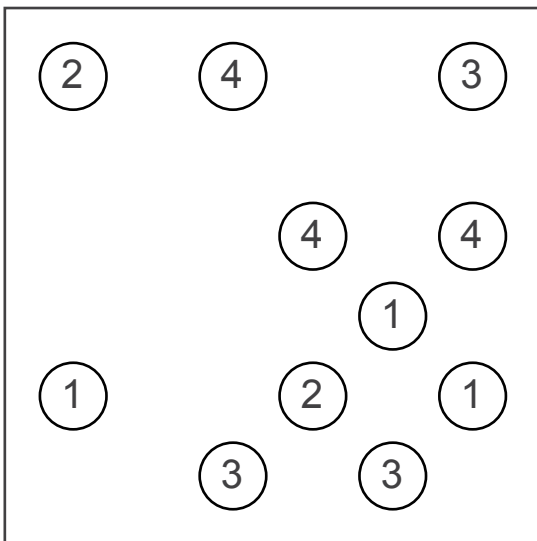

0606 BUILD BRIDGES 79

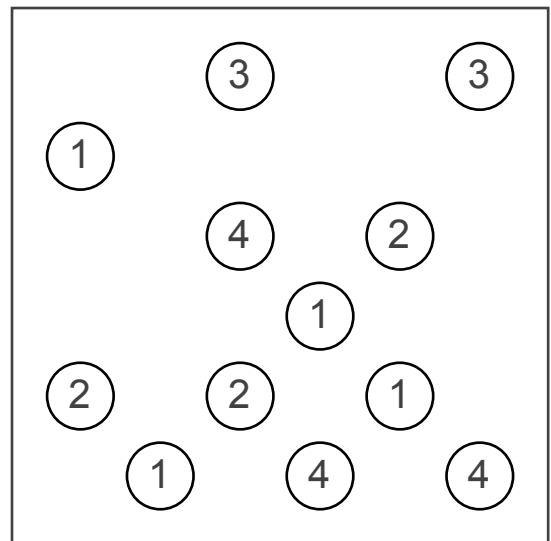

0606 BUILD BRIDGES 80

ANSWERS

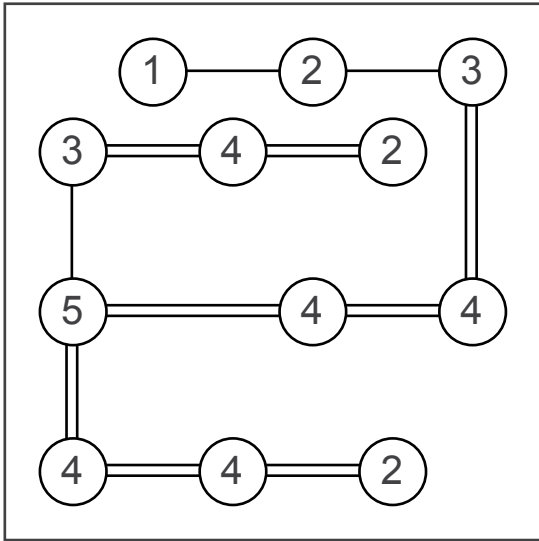

0606 BUILD BRIDGES 77

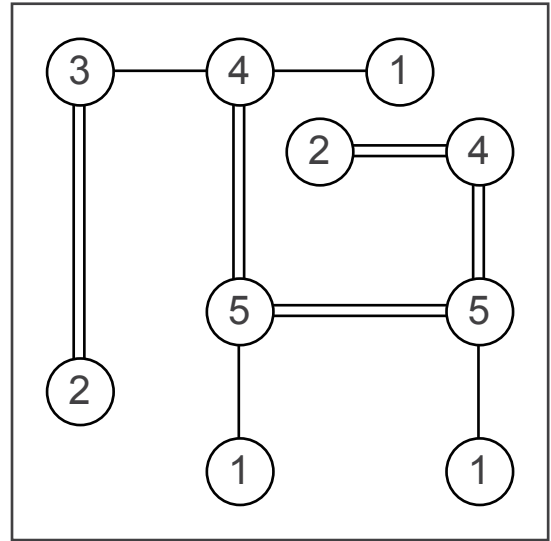

0606 BUILD BRIDGES 78

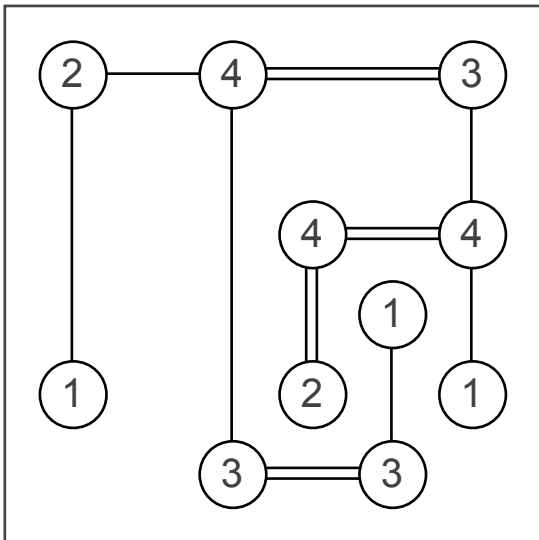

0606 BUILD BRIDGES 79

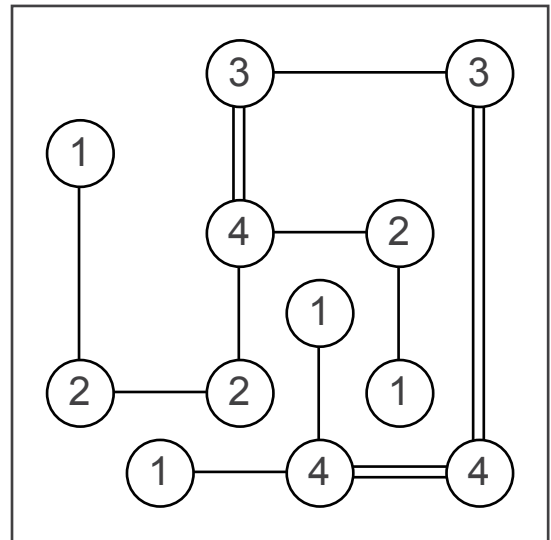

0606 BUILD BRIDGES 80